

Headboard hardware located in velcro pouch in back of headboard.

Footboard hardware located in one end of the footboard/siderails.

## ASSEMBLY INSTRUCTIONS

Item No: BJCB#8000 / BJCB#9000

Description: JACOB QUEEN/KING BED

Thank you for purchasing this quality product. Be sure to check all packing material carefully for small parts that may have come loose inside the carton during shipment.



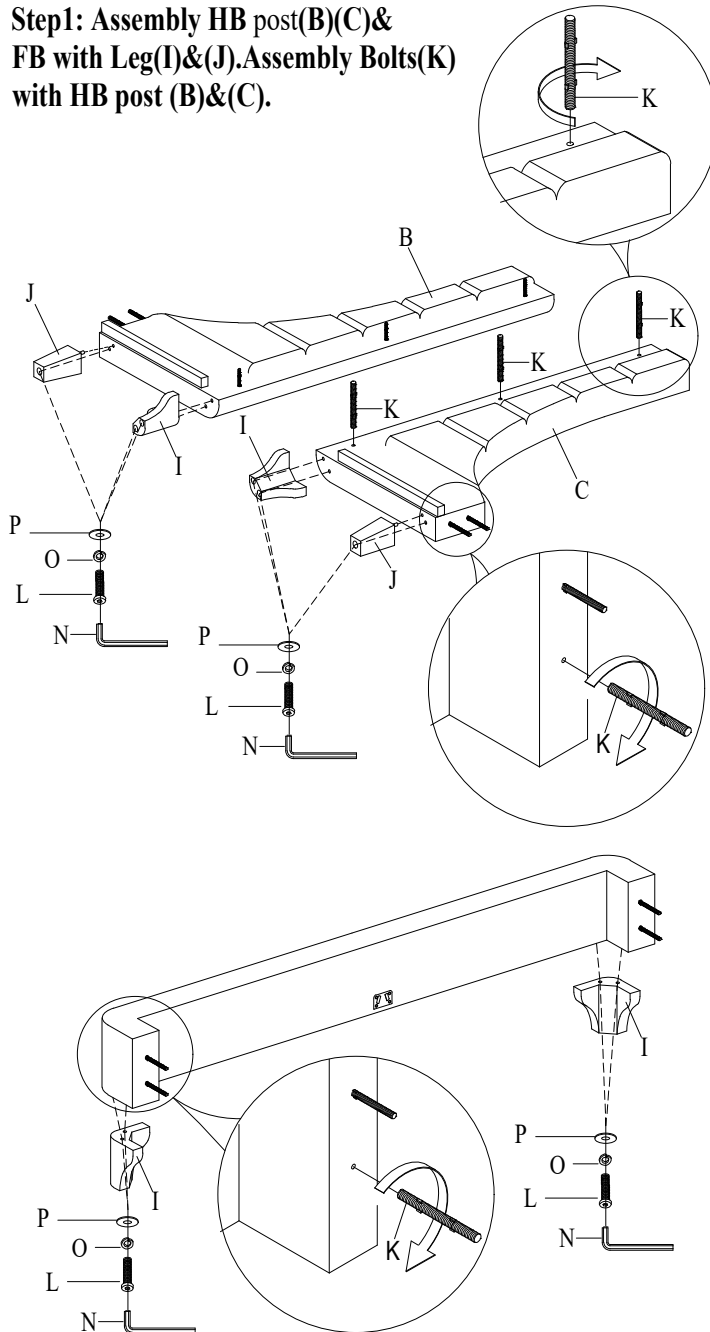



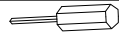

**Step1: Assembly HB post(B)(C)& FB with Leg(I)&(J).Assembly Bolts(K) with HB post (B)&(C).**

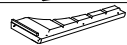
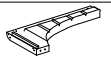







### TOOLS REQUIRED(NOT PROVIDED)

 Philips Screwdriver











### PARTS LIST:





No.	Description	Sketch	Quantity
A	Headboard		1 PC
B	HB post Left		1 PC
C	HB post Right		1 PC
D	Footboard		1 PC
E	Side Rail		2PCS
F	Center Rail Support Leg		3PCS
F1	Slat Support Leg		8PCS
G	Center Rail		1PC
H	Slats		4PCS
I	Leg		4PCS
J	Leg		2PCS

### HB HARDWARE LIST: (4) LEG FOR HEADBOARD

No.	Description	Sketch	Size	Quantity
K	Bolt		Ø5/16"*4"	10PCS
L	Bolt		Ø5/16"*4"	6PCS
N	Allen Key		M5*4"	1PC
O	Spring Washer		Ø5/16"	16PCS
P	Flat Washer		Ø5/16"	16PCS
S	Spanner		M12	1PC
T	Nut		M8	10PCS

### FB HARDWARE LIST: (2) LEG FOR FOOTBOARD

No.	Description	Sketch	Size	Quantity
K	Bolt		Ø5/16"*4"	4PCS
L	Bolt		Ø5/16"*4"	4PCS
M	Bolt		Ø5/16"*1-1/2"	11PCS
N	Allen Key		M5*4"	1PC
O	Spring Washer		Ø5/16"	8PCS
P	Flat Washer		Ø5/16"	19PCS
Q	Screw		Ø8*3/4"	4PCS
R	Screw		Ø8*1-1/2"	8PCS
S	Spanner		M12	1PC
T	Nut		M8	4PCS
U	Metal bracket		50*32*30*2	2SET

K	Bolt		Ø5/16"*4"	14PCS
L	Bolt		Ø5/16"*4"	10PCS
O	Spring Washer		Ø5/16"	10PCS
P	Flat Washer		Ø5/16"	10PCS
N	Allen Key		Ø5/16"*4"	1 PC

## ASSEMBLY INSTRUCTIONS





Item No: BJC#8000 / BJC#9000

Description: JACOB QUEEN/KING BED

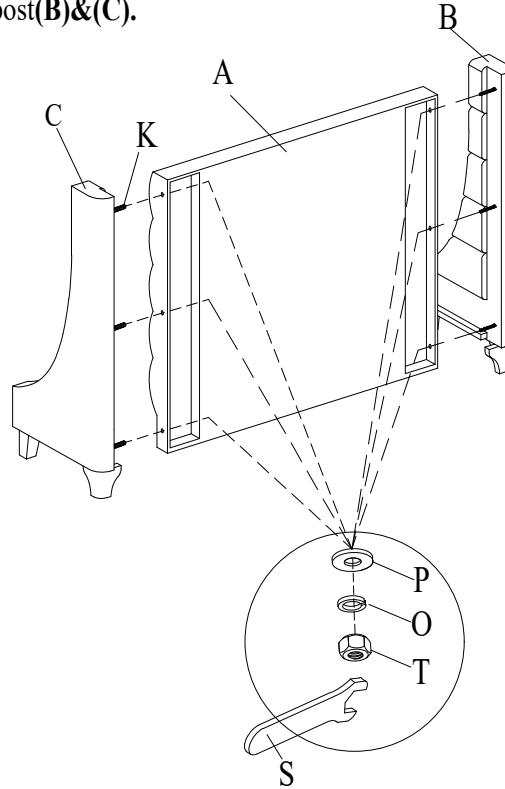
Thank you for purchasing this quality product. Be sure to check all packing material carefully for small parts that may have come loose inside the carton during shipment.





Step2: Assembly HB(A) with post(B)&(C).

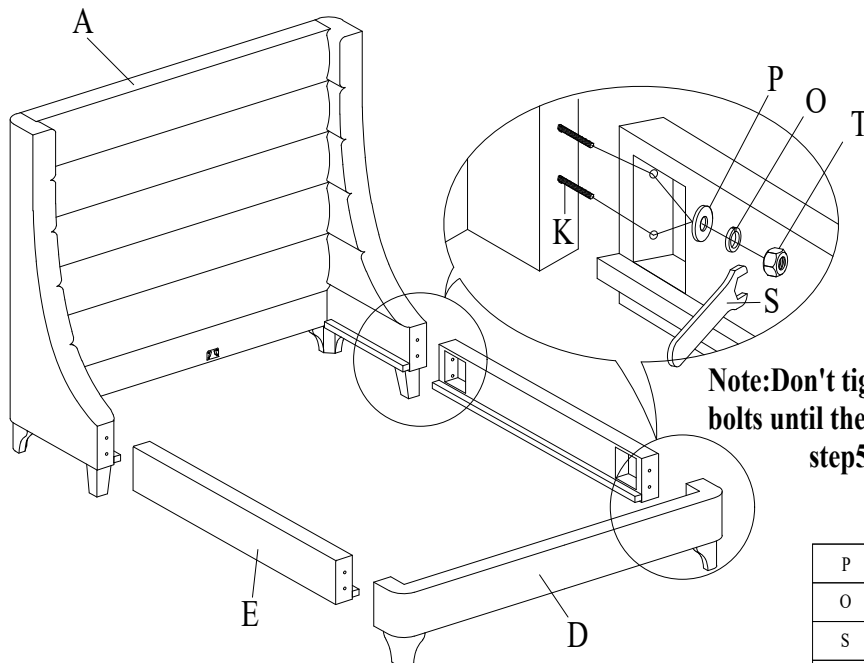

P	Flat Washer		Ø5/16"	6PCS
O	Spring Washer		Ø5/16"	6PCS
S	Spanner		M12	1PC
T	Nut		M8	6PCS

Step3: Assembly Side Rail(E) with HB(A)&FB(D).



P	Flat Washer		Ø5/16"	8PCS
O	Spring Washer		Ø5/16"	8PCS
S	Spanner		M12	1PC
T	Nut		M8	8PCS

## ASSEMBLY INSTRUCTIONS

Item No: BJCB#8000 / BJCB#9000

Description: JACOB QUEEN/KING BED

Thank you for purchasing this quality product. Be sure to check all packing material carefully for small parts that may have come loose inside the carton during shipment.

### Step4: Assembly Center Rail(H) with HB(A)&FB(D).

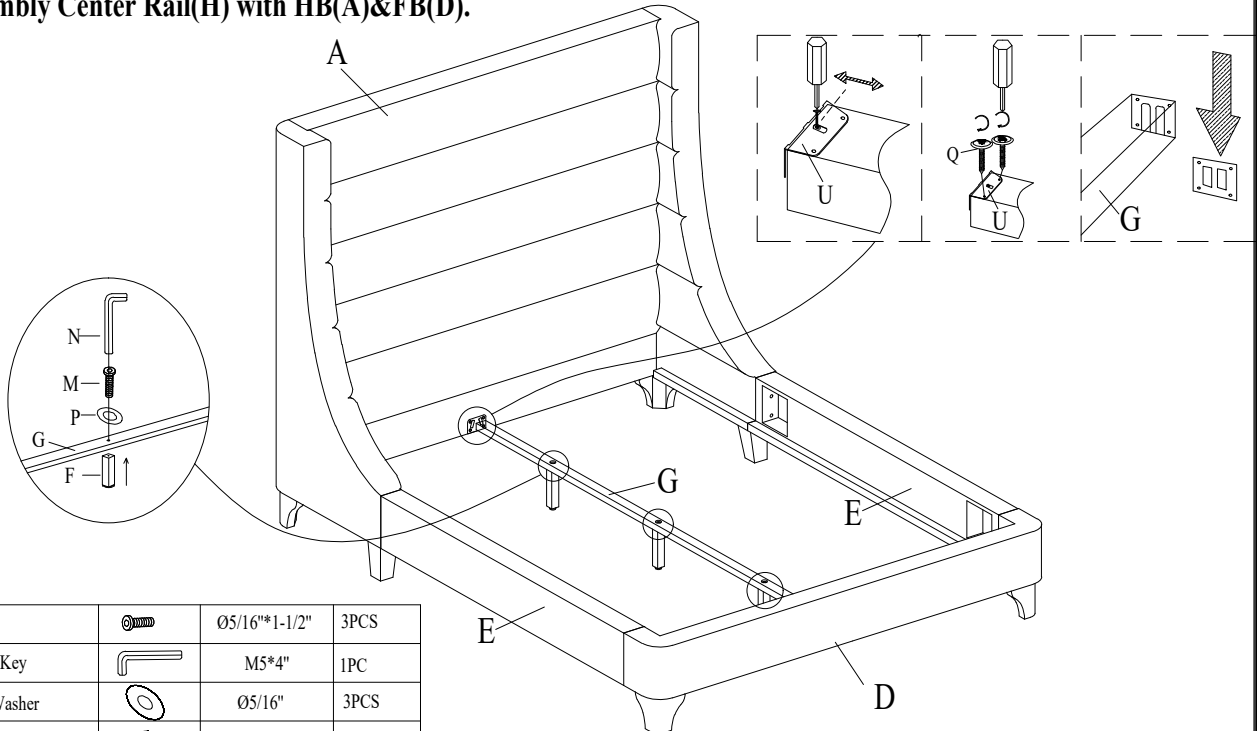

M	Bolt		Ø5/16"*1-1/2"	3PCS
N	Allen Key		M5*4"	1PC
P	Flat Washer		Ø5/16"	3PCS
Q	Screw		Ø8*1"	4PCS

### Step 5: Assembly slat(H) with side Rail(E).

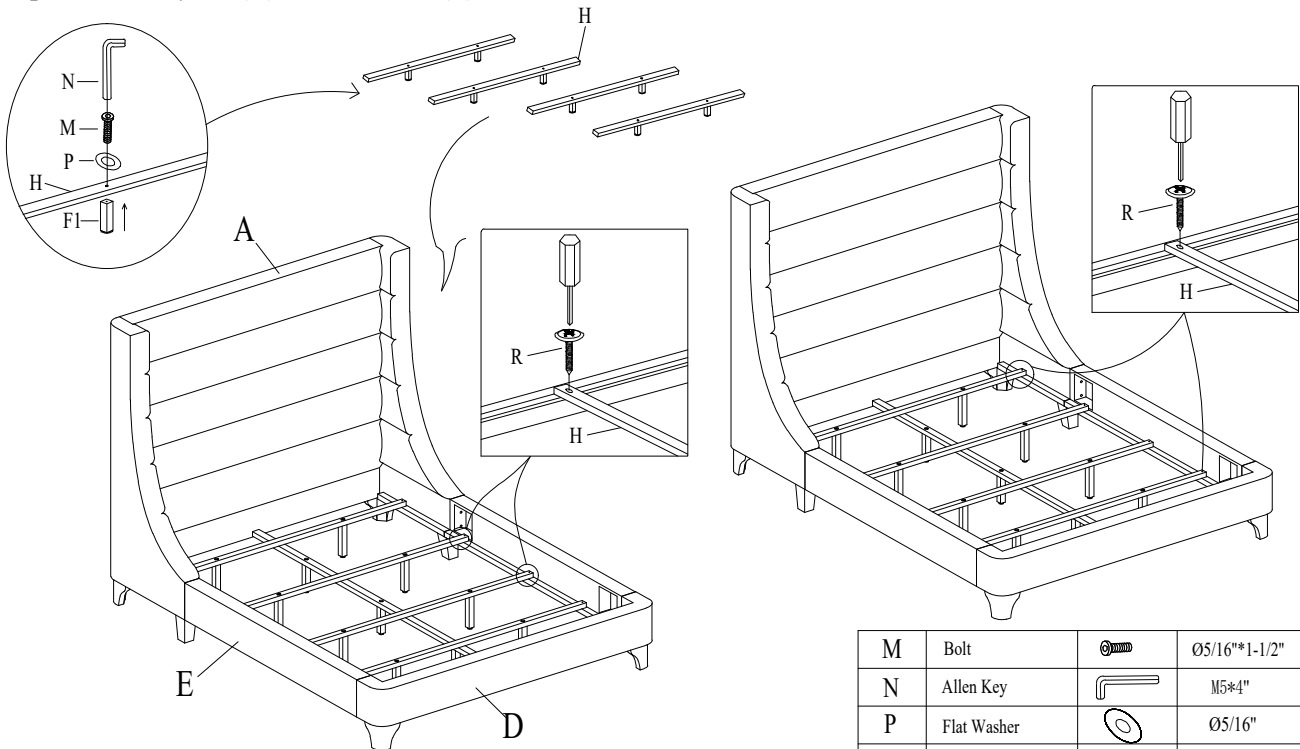

M	Bolt		Ø5/16"*1-1/2"	8PCS
N	Allen Key		M5*4"	1PC
P	Flat Washer		Ø5/16"	8PCS
R	Screw		Ø8*1-1/2"	8PCS

**ASSEMBLY INSTRUCTIONS**

**Item No: BJCB#8000 / BJCB#9000**

**Description: JACOB QUEEN/KING BED**

**Thank you for purchasing this quality product. Be sure to check all packing material carefully for small parts that may have come loose inside the carton during shipment.**

**Step 6: Completed assembly for a regular bed.**

