



Parker House
FURNITURE

Assembly Instruction

Item No: CAT#420

Description : 22 IN. OPEN TOP BOOKCASE

Rev 3 :2025-05-07

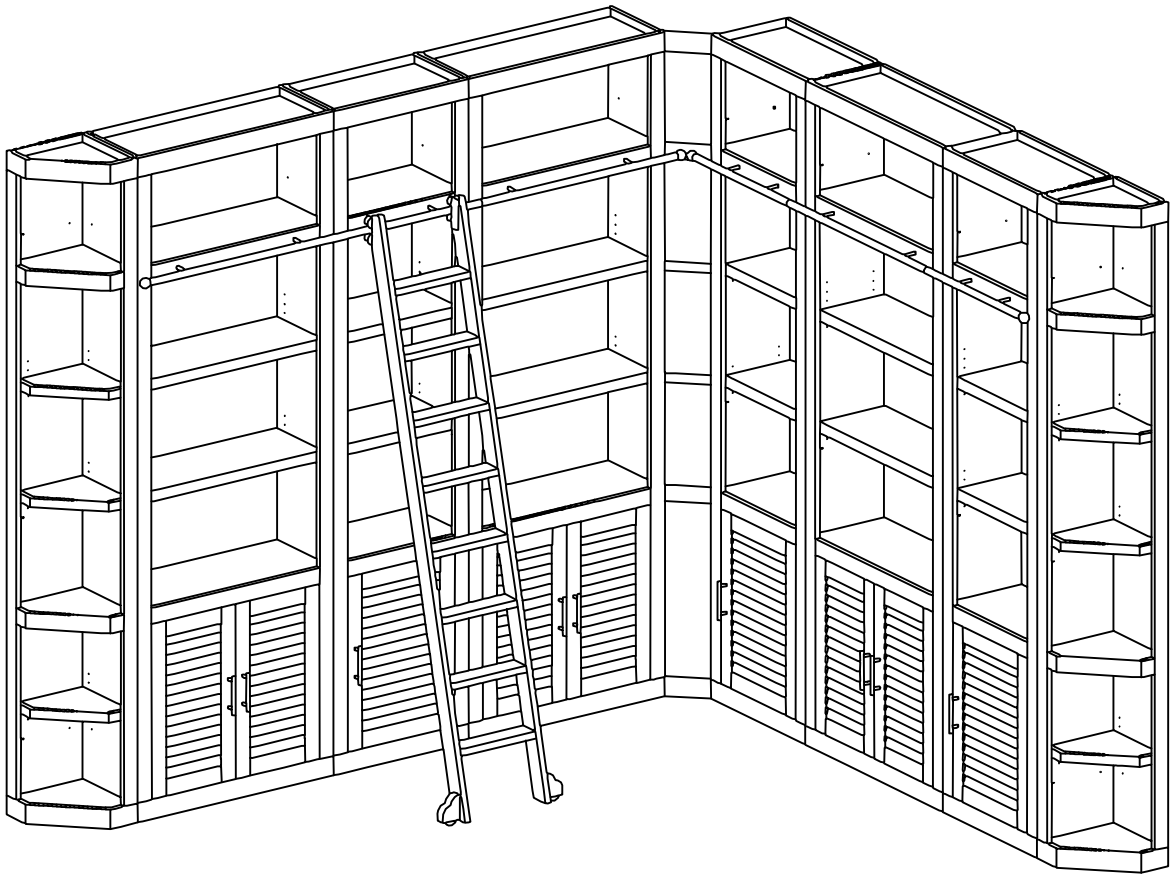



Parker House
FURNITURE

















Assembly Instruction

Item No: CAT#420

Description : 22 IN. OPEN TOP BOOKCASE

Rev 3 :2025-05-07

HARDWARE LIST

No	Description	Sketch	Q'TY
A	Wrench		1PC
B	Allen wrench 4mm		1PC
C	Allen wrench 2.5mm		1PC
D	Bolt Ø 1/4" x1" (Ø15mm)		6PCS
E	Screw cap Ø 1/4" x5/8" Ø15mm		6PCS
F	Metal ball		1PC
G	Sleeve		1PC
H	Ladder rail		1PC
I	Flat washer Ø16mm		2PCS
J	Hex nut		2PCS
K	Lock washer		2PCS
L	Flat washer white zinc Ø16mm		2PCS
M	Shelf pin		4PCS
N	Screw Ø4x5/8"		4PCS
O	Allen wrench 4mm		1PC
P	Allen wrench		1PC

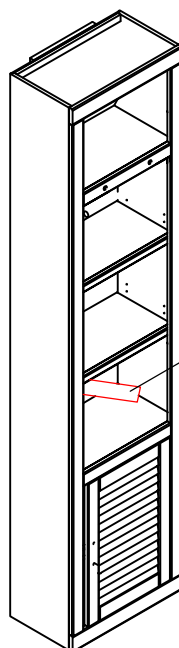
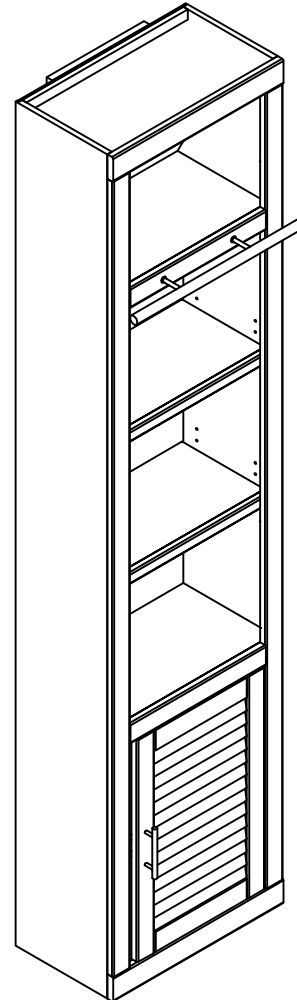

Hardware and
ladder rail pack is here

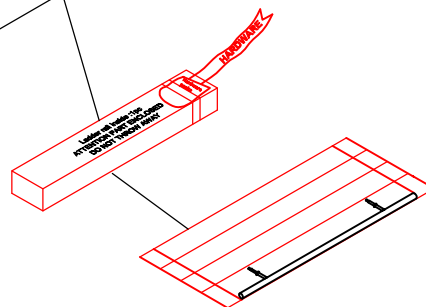



Parker House
FURNITURE

Assembly Instruction

Item No: CAT#420

Description : 22 IN. OPEN TOP BOOKCASE

Rev 3 :2025-05-07

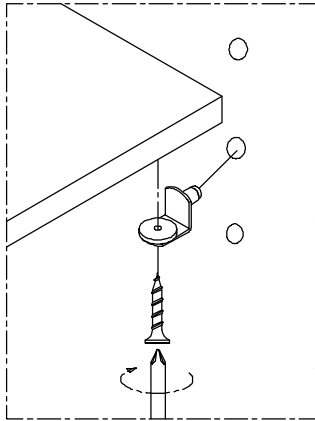

To adjust the shelf height, remove the four screws under each shelf pin. once removed, place shelf pins at desired height and re-screw shelf pins.

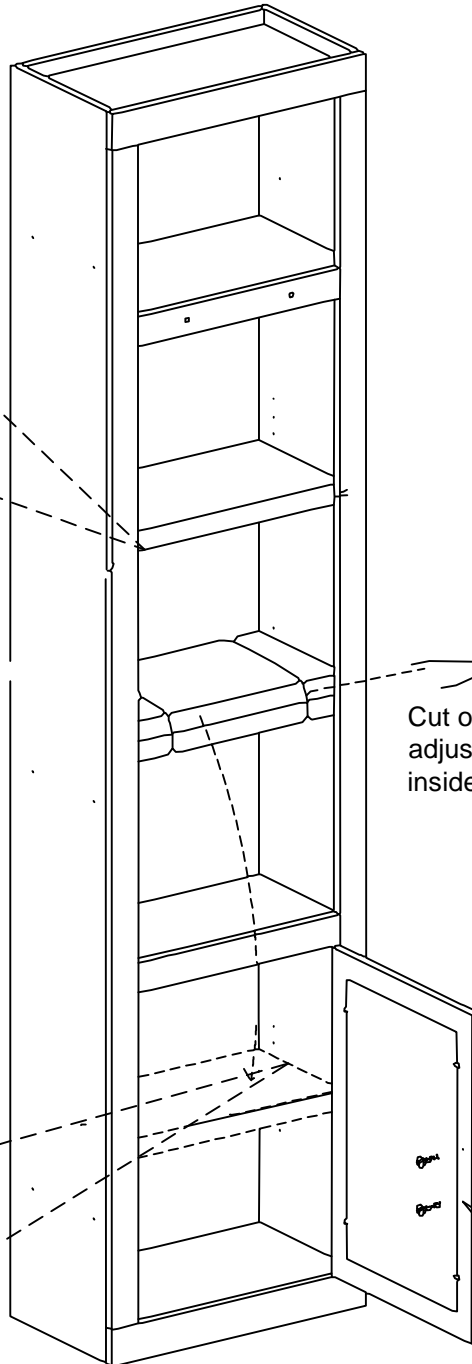
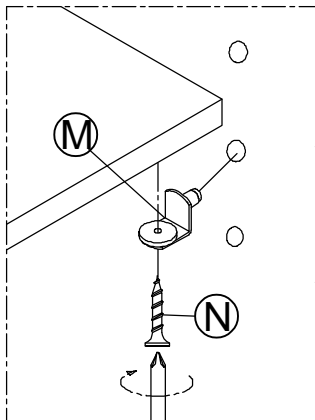

Cut off the ropes and take down the adjustable shelf, then place the shelf inside the door on top of the shelf pins.

Open the doors and take off the pulls installed on the back of doors, then reattach the pulls on the front of doors as shown.

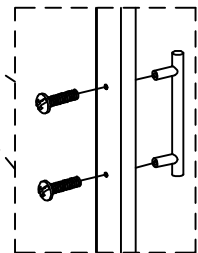



Parker House
FURNITURE

Assembly Instruction

Item No: CAT#420

Description : 22 IN. OPEN TOP BOOKCASE

Rev 3 :2025-05-07

Remove the decorative bolt before mounting the ladder rail. Please: Do not fully tighten ladder rail bolts until library wall is assembled, leveled, and ladder rails between units are attached.

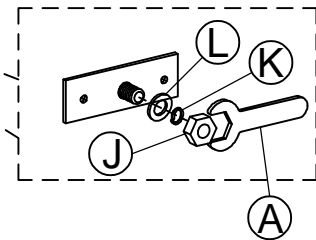
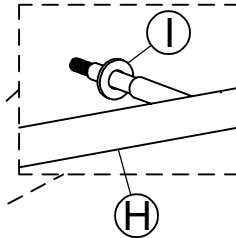
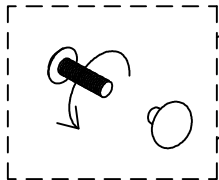

Use a screwdriver to loosen the screw of each Tab before flipping up the Tabs.

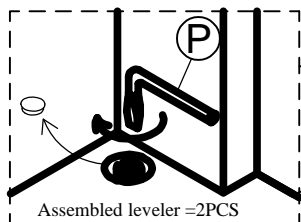
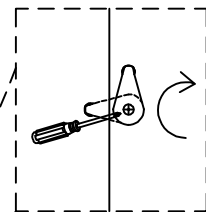

Inside the bottom panel on the forward RSF side is a cap with the leveler below. To adjust the leveler remove the cap and turn the leveler to adjust the height of the bookcase with Allen wrench(P).

The front door panel is reversible. To change the the door panel, flip up each tab and push door panel out. Turn the panel around and place back inside the door and flip the tabs down to hold it in place.



Parker House
FURNITURE

Assembly Instruction

Item No: CAT#420

Description : 22 IN. OPEN TOP BOOKCASE

Rev 3 :2025-05-07

To reverse the back panel, unscrew the cleat and back panel as shown in the diagram below. Turn the back panel to the desired finish and re-screw.

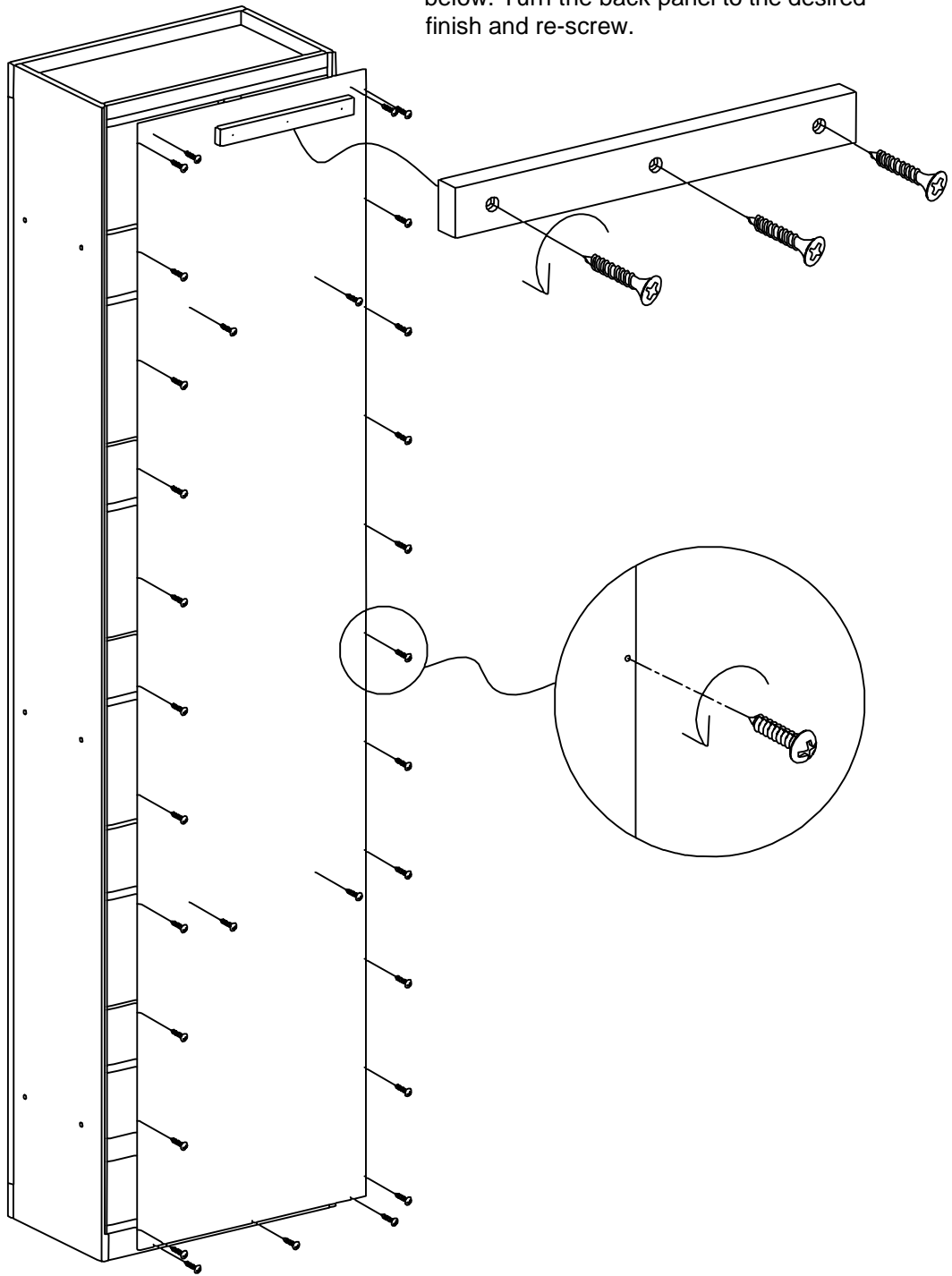



Parker House
FURNITURE

Assembly Instruction

Item No: CAT#420

Description : 22 IN. OPEN TOP BOOKCASE

Rev 3 :2025-05-07

If setting up an end piece, use allen wrench (C) to loosen retaining screw found on each rail end, secure ladder rail finial (F) to ladder rail end to complete finished look.

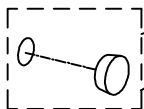
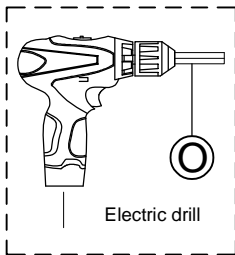
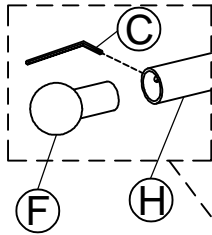

Remove the wood plugs before connecting the cabinets together.

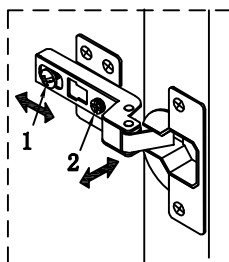

The library self closing hinges can be adjusted with the above diagram screws.

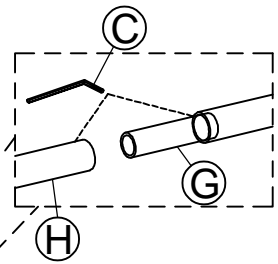

To connect ladder rails, loosen retaining screw found on each rail end, insert ladder rail coupler (G) about 1" on one side, and tighten. Align cabinets and push together, aligning ladder rails in the process. Tighten opposite retaining screw to secure ladder rail coupler.

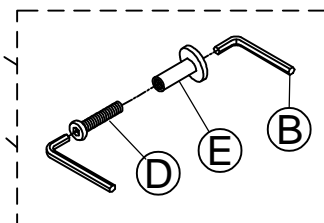
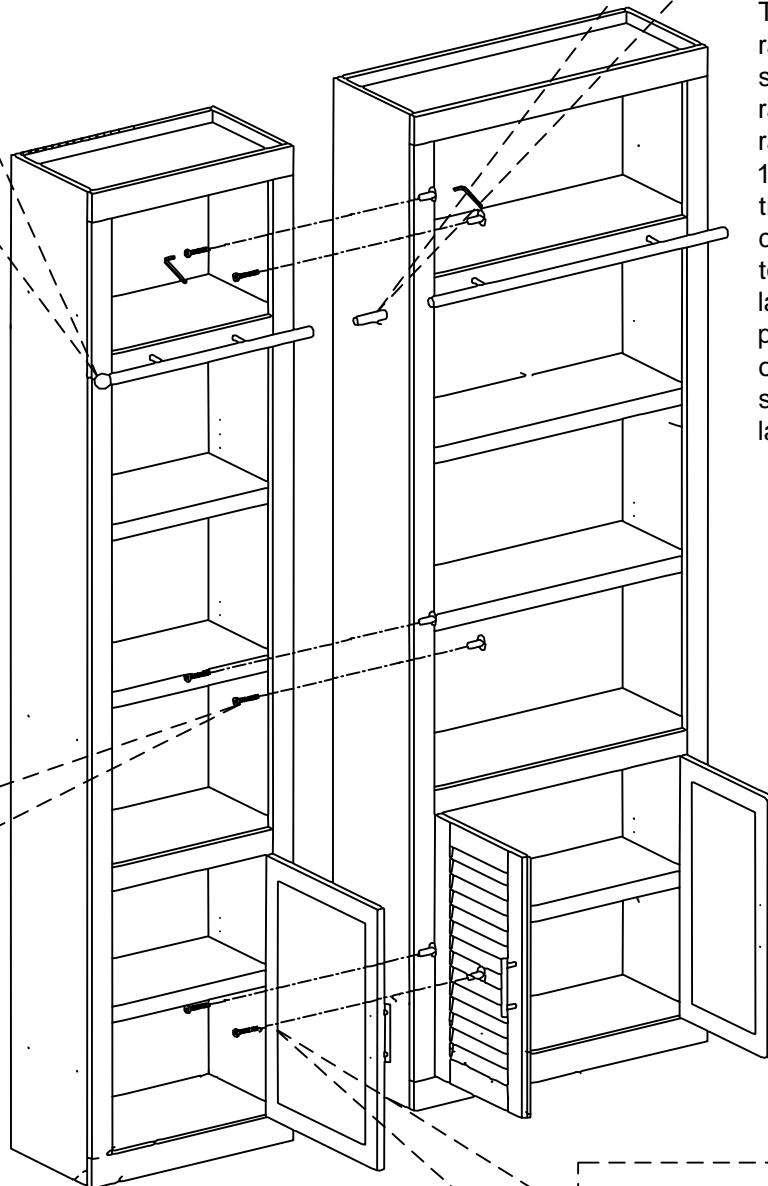

Align and connect cabinets with Connector Bolt (D) and Connector Cap (E).



Parker House
FURNITURE

Anti-Tip Hardware Installation Instructions

Rev 3 :2025-05-07

Notice: In homes where small children may be present, Parker House recommends that steps be taken for certain furniture items to prevent or minimize the risk of tip-over. This furniture is equipped with Tip-over Restraint Hardware for use to minimize this risk, if used. Please follow below installation steps. Parker House recommends that parents and guardians periodically visit the U.S. Consumer Product Safety Commission (CPSC) website at <http://www.cpsc.gov/> and stay up to date on all issues related to children's product safety.

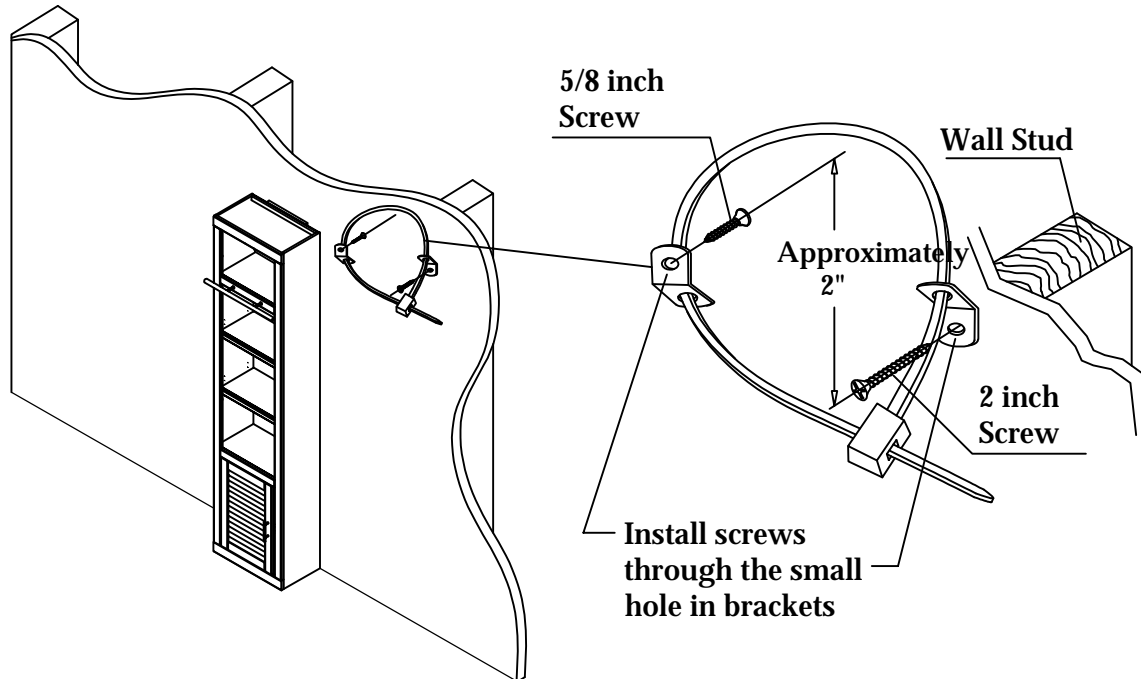

1. Temporarily locate the furniture to near its final location in the room next to a wall. Locate a wall stud behind your furniture and also mark the stud's location on the back of your furniture.
2. Firmly attach one bracket to the stud approximately 2" below the top of the furniture with the 2 inch long Wood Screws provided. It may be necessary to drill 3/32 dia. pilot holes for the screws.
3. Firmly attach the other bracket onto a solid, structural part on the back of the furniture using the 5/8 inch long Wood Screws. It may also be necessary to pilot bore for these screws.
4. Move the furniture into its final position, taking care to line up the wall bracket with the furniture bracket. Thread a strap through the bracket as shown in the illustration. Tighten strap until snug but do not over tighten.

Caution: Parker House assumes no liability for improper installation or excessive loads placed on screws, brackets or straps. Failure to detach this restraint before moving furniture may result in personal injury and property damage.

Warning: This tip-over restraint is not to be a substitute for proper adult supervision. Do not allow children to climb on furniture. Items left on top of the TV and furniture, such as toys, remote controls, and treats might tempt young children to climb. Push the TV as far back as possible from the front of its stand. Place electrical cords out of a child's reach, and teach children not to play with the cords.