

Assembly Instructions

Caldwell Sectional

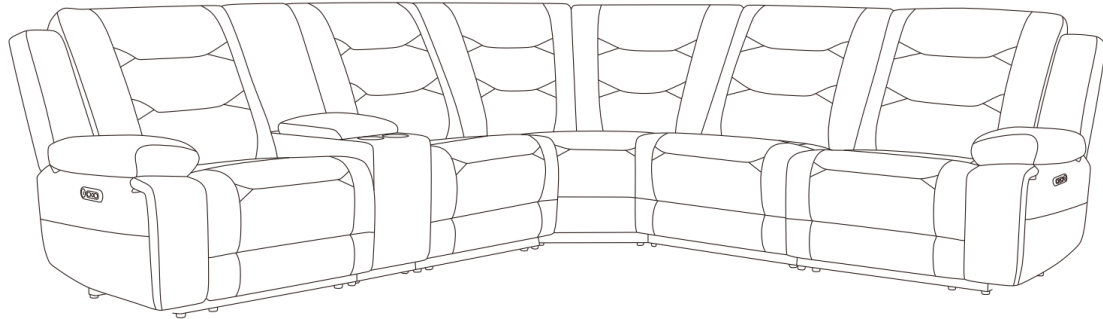

BEFORE ASSEMBLY

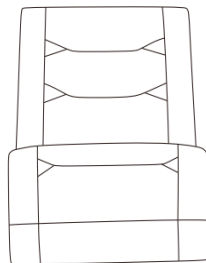

Thank you for purchasing this quality product. This product has been designed for easy assembly and constructed for durability. Please take the time to read and follow the assembly instructions carefully.

Power Armless Recliner



Part List

When unpacking, please be careful not to discard any parts with the packaging. Before continuing, please make sure you have the following parts:

No	Description	Sketch	Qty
A	Body		1 PC
B	Back Cushion		1 PC

Step 1

Before removing the product from the carton, detach and remove the plywood from the frame using screw driver as shown in the diagram.

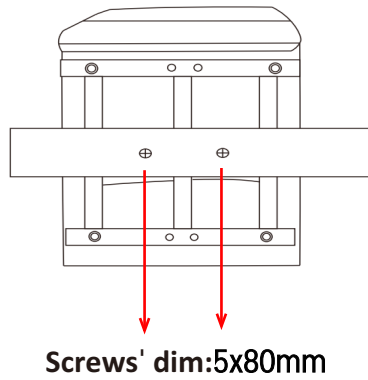

Step 2

Untie the power cord.

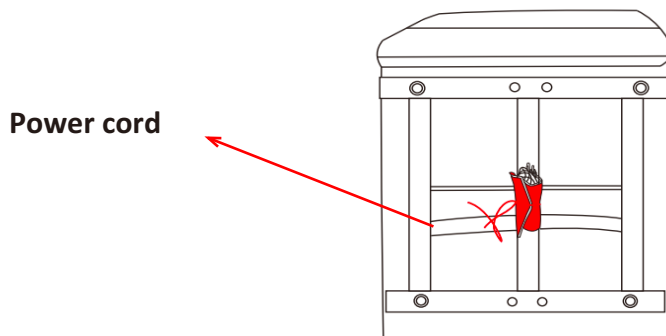

Step 3

1. Install the Backrest(B) into the Seat(A) by positioning the female metal receiver brackets over the male metal posts. Ensure that female metal receiver brackets on each side of the backrest are line up with the seat metal posts. Push down the female brackets over male posts simultaneously until each side is locked into place and an audible "click" is heard .

2. Connect the wire.

3. Attach the flap to the seat frame by pulling the flap down, and pressing the bottom hem under the seat base , connecting the velcro.

1.

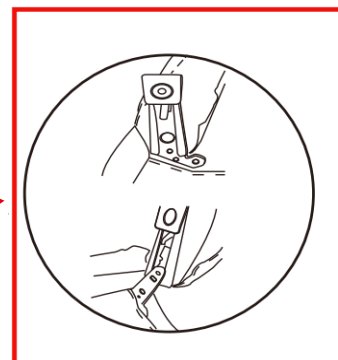
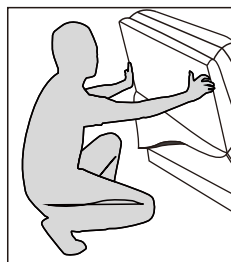
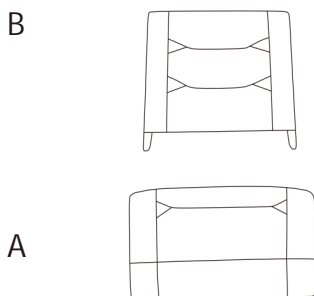

2.

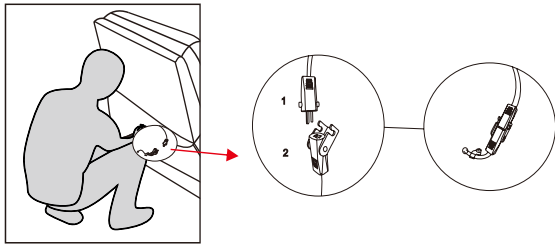

3.

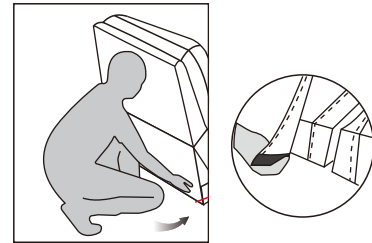

Seat contains 2.2 Density Foam, Back Cushion contains 100% Fiber.

Sectional Connect

1. Begin sectional connection by placing the pieces in the desired location in the room. Connect the pieces together using the brackets on the sides of each piece.

2. Plug in the cable.

