

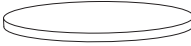











Assembly Instructions

ITEM#: CVFZR6206

Please read instruction before you start assembling

PARTS LIST	PART	DESC	QTY	HARDWARE LIST	HARDWARE	DESC	QTY
1		Table top	1	A		Small washer	14
2		Middle post	1	B		Short bolt	10
3		Cross bracket	1	C		Long bolt	4
4		Support bar	8	D		Allen key	1
5		Base bracket	1	E		Large washer	2
				F		Large bolt	2
				G		Allen key	1

Step 1

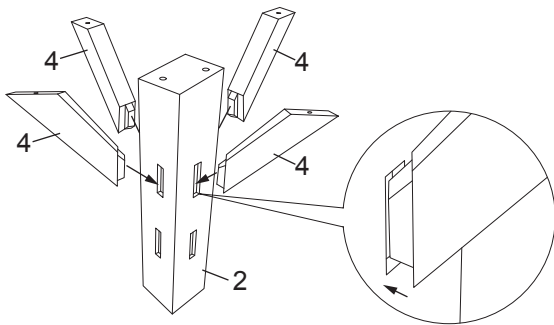

Step 2

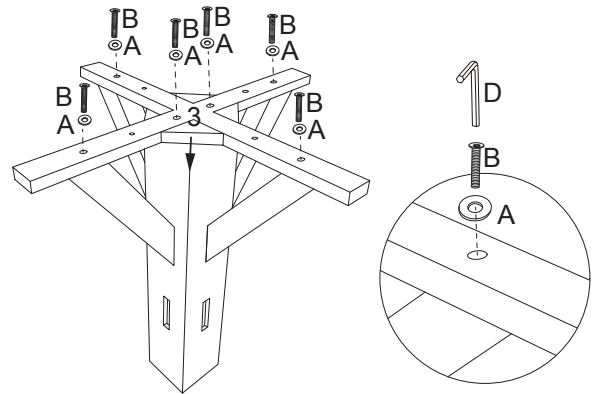

Step 3

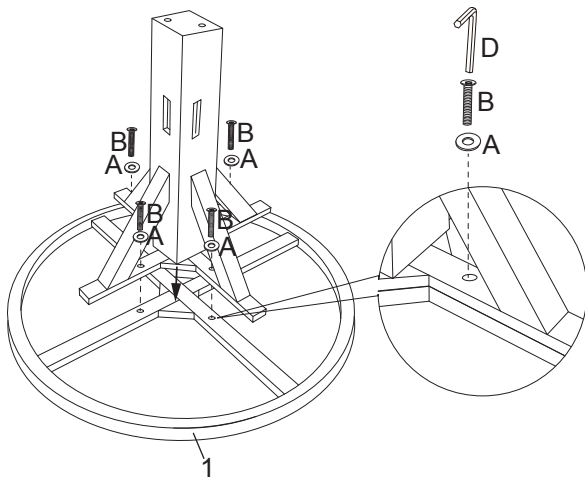

Step 4

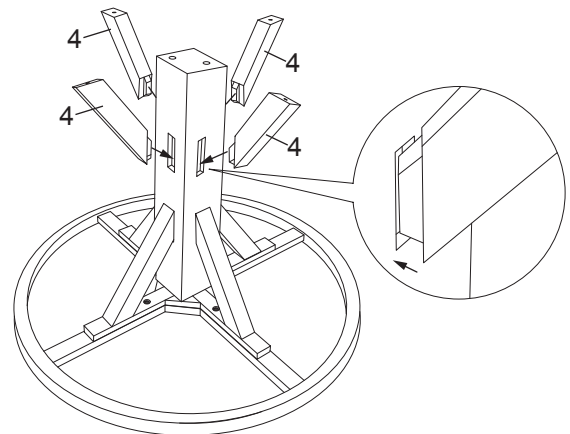

Step 5

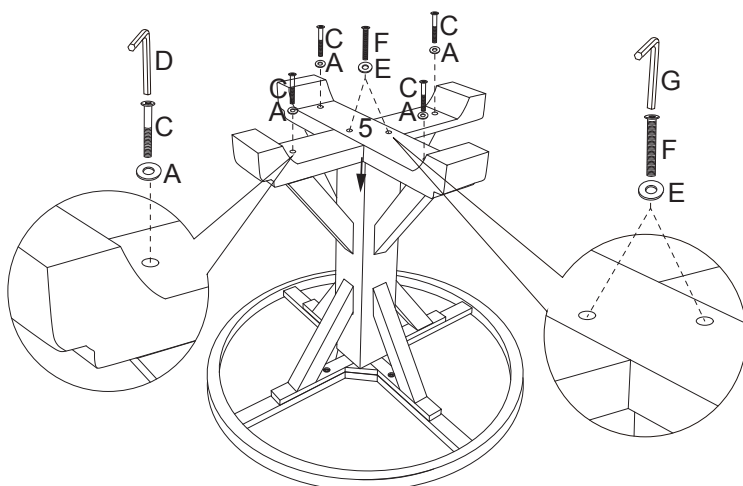

Step 6

