







Assembly Instruction Sheet

ITEM:CVFZR6197

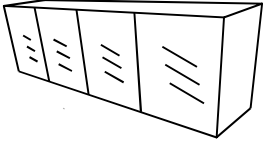
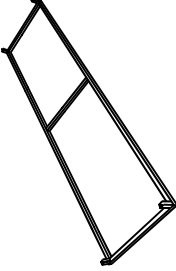
A	 6x16mm	22pcs	1		2		3	
B	 φ6mm	22pcs						
C	 M6x16mm	22pcs						
D	 4mm	1pc						

APPROXIMATE ASSEMBLY TIME

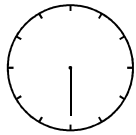

0.5 HOUR

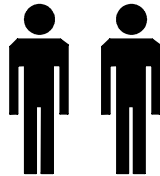

2 PERSONS ASSEMBLY

FLOOR AREA
3MX1.5M

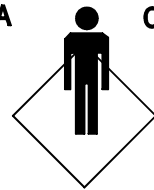

CEILING HEIGHT
2M

REQUIRED ASSEMBLY SPACE

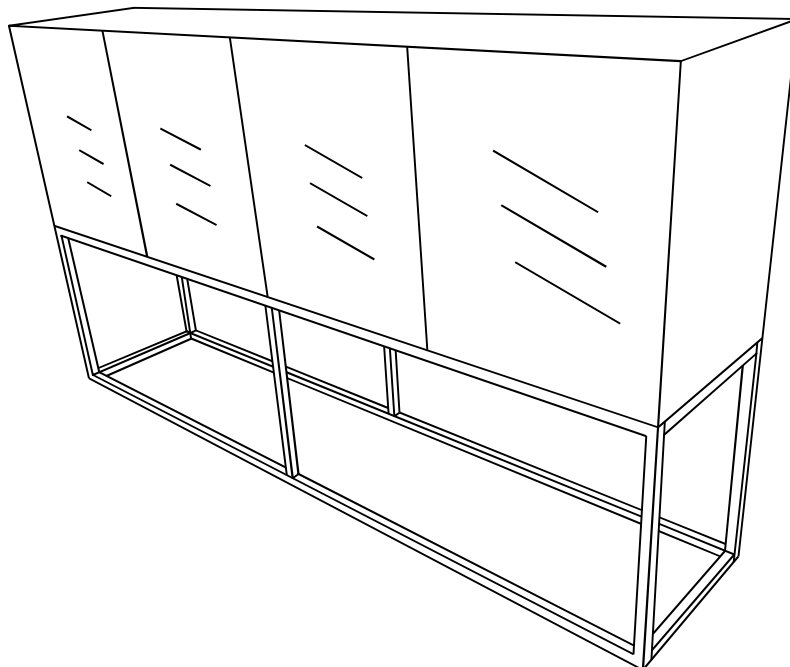

Assembly Instruction Sheet

ITEM:CVFZR6197

Setup 1

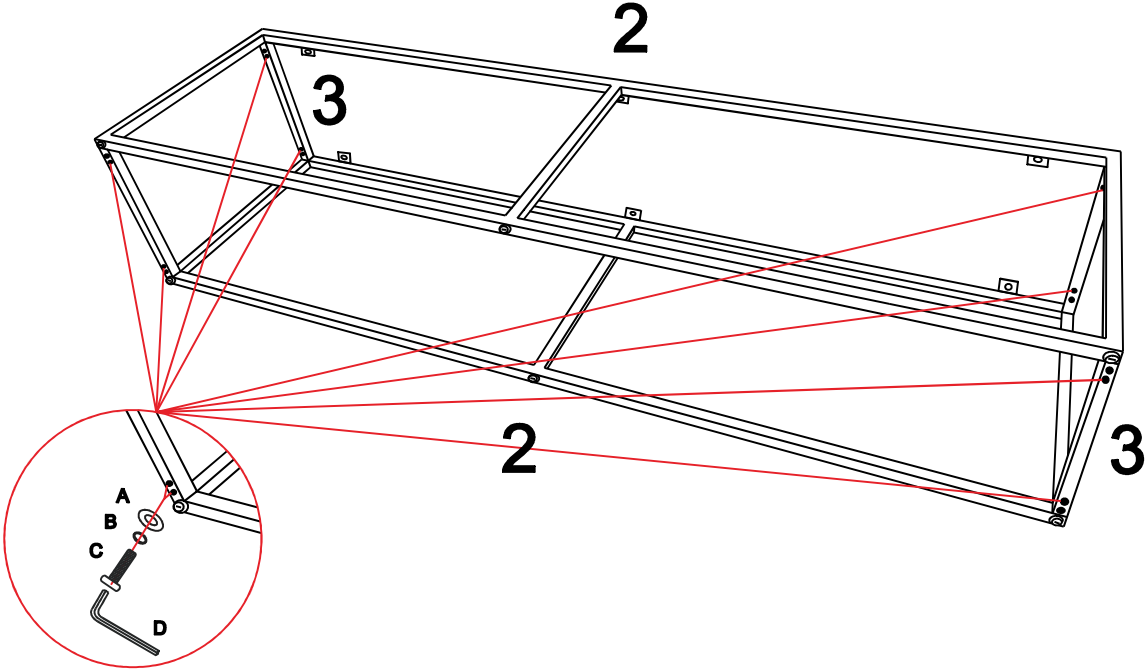

Setup 2

