

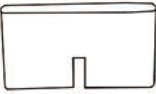



# ASSEMBLY INSTRUCTION

CVFNR4622

## PARTS

S.NO.	DESCRIPTION	QTY
E	 TOP	1 PC
F	 LEG	2 PCS

## HARDWARE

S.NO.	DESCRIPTION	QTY
A	 ALLEN SCREW SIZE : 6x20mm	4 PCS
B	 WASHER SIZE : 8x25mm	4 PCS
C	 SPRING WASHER SIZE : 8mm	4 PCS
D	 ALLEN KEY SIZE : 4mm	1 PC

### STEP 1

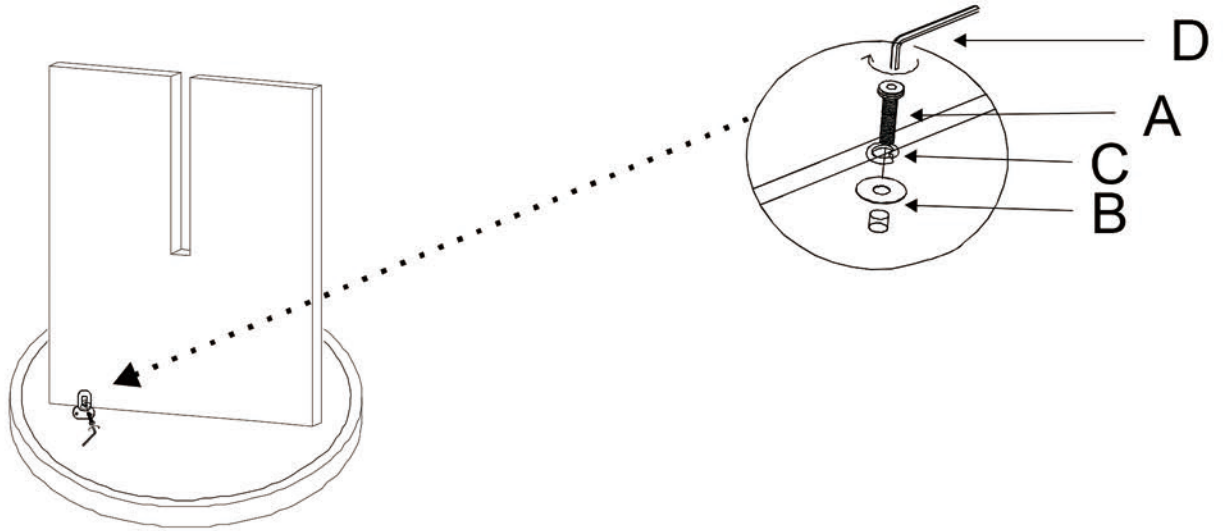

### STEP 2

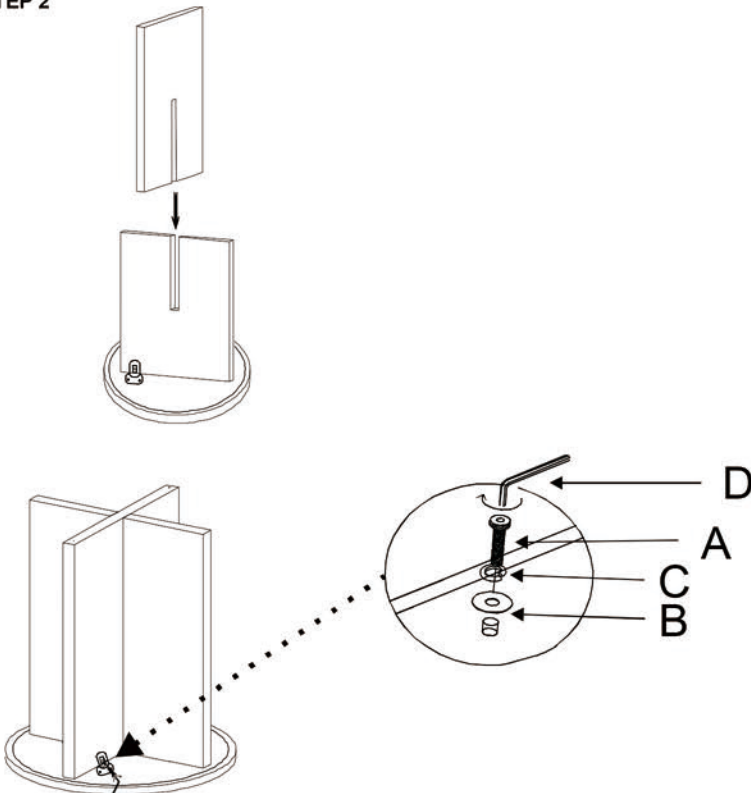

### STEP 3

COMPLETE

